

I

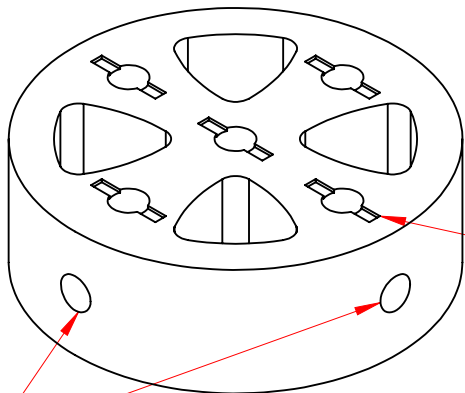

負牙標記
"-" block
if any of
the threaded
hole has a
"-" mark

有側孔
With side hole

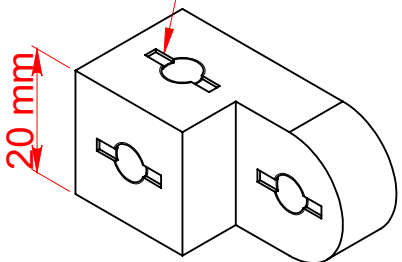

II

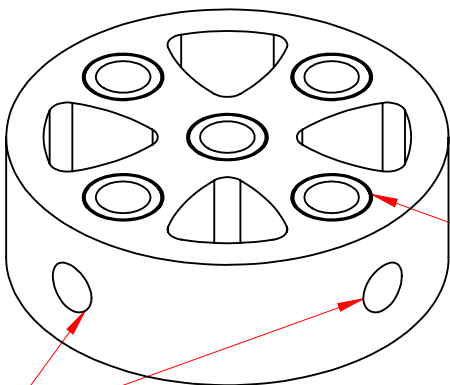

負牙標記
"-" block
A circular
ring outside
each threaded
hole

有側孔
With side hole

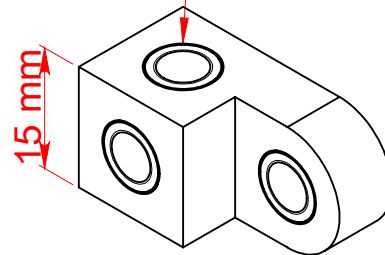

V

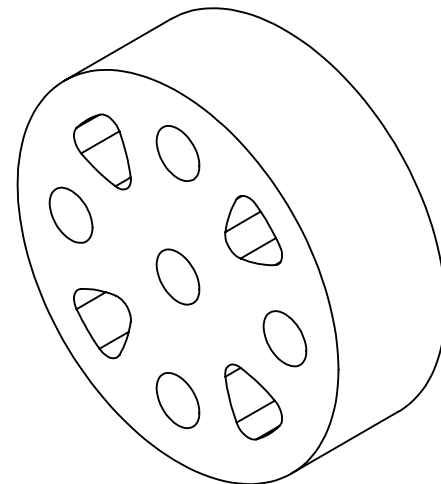

III

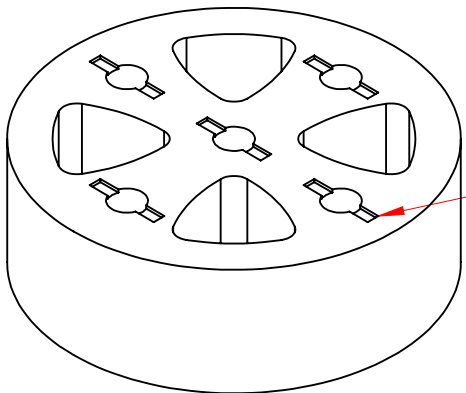

負牙標記
"-" block
if any of
the threaded
hole has a
"-" mark

20 mm

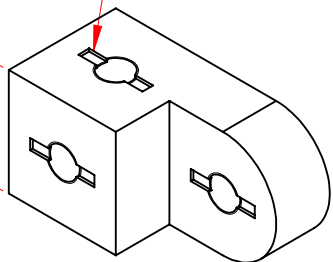

IV

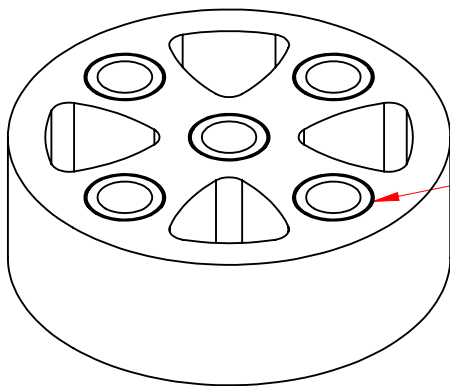

負牙標記
"-" block
A circular
ring outside
each threaded
hole

15 mm

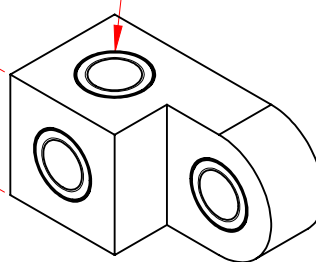

10 mm

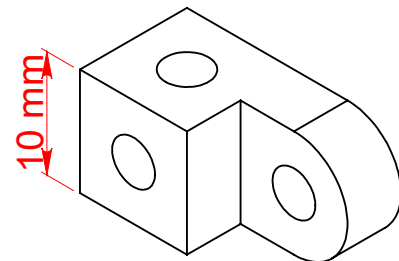

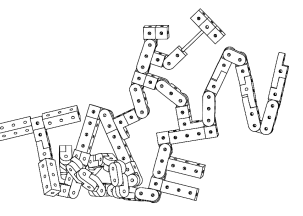

I

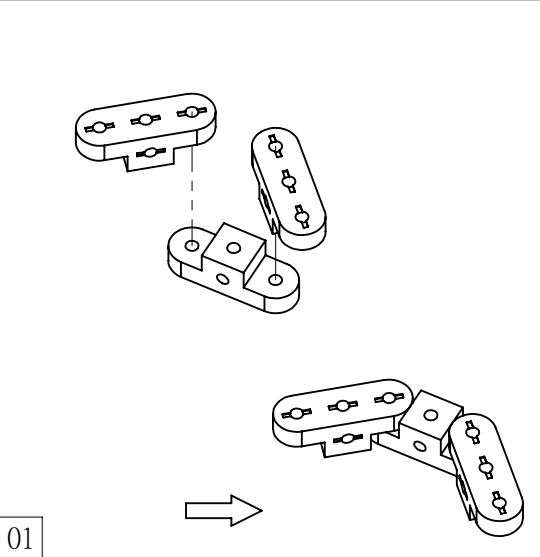
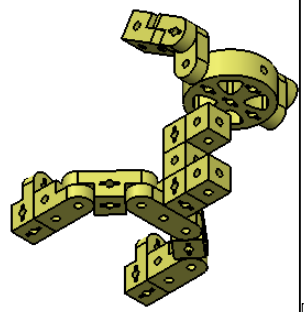
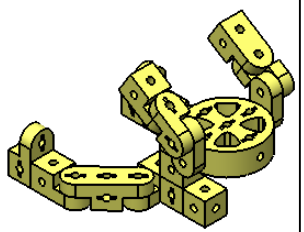
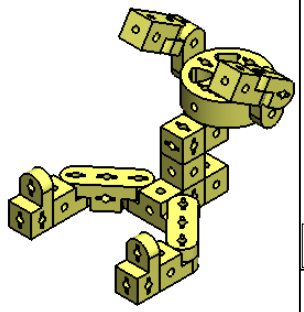

01

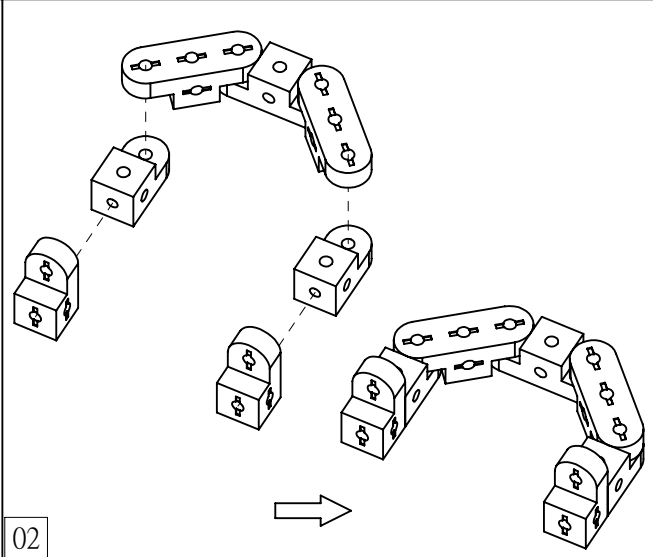

02

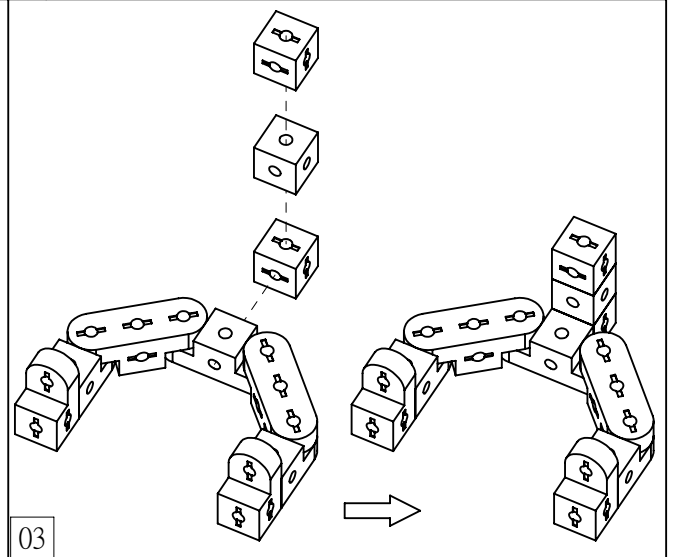

03

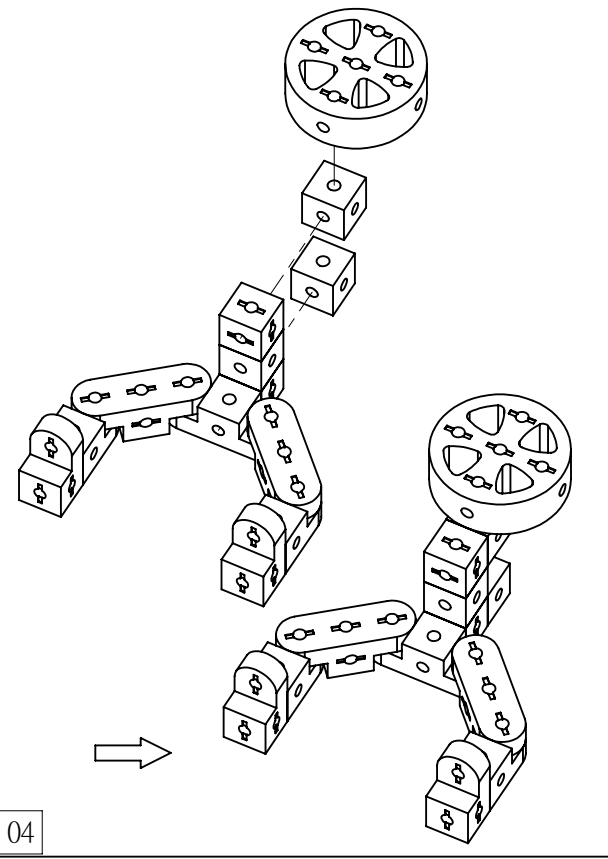

04

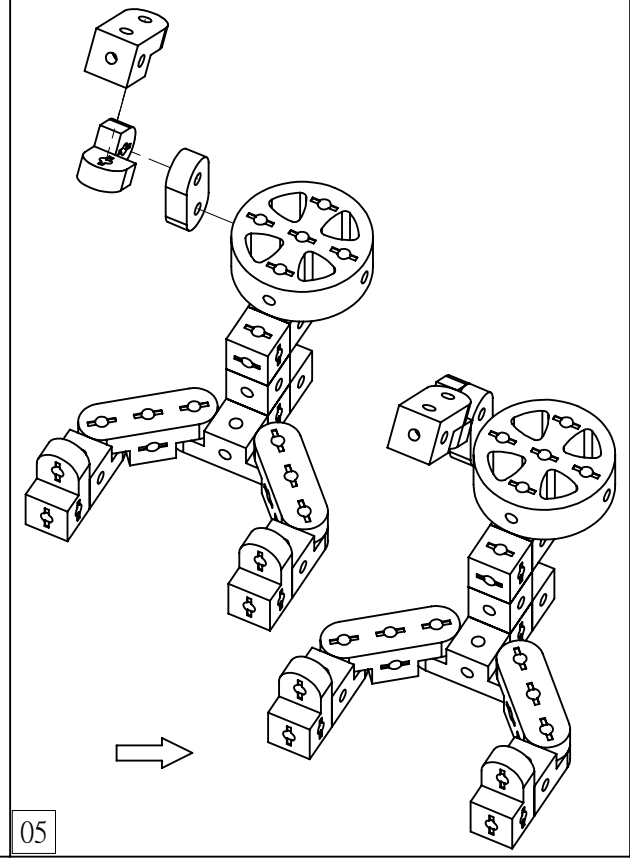

05

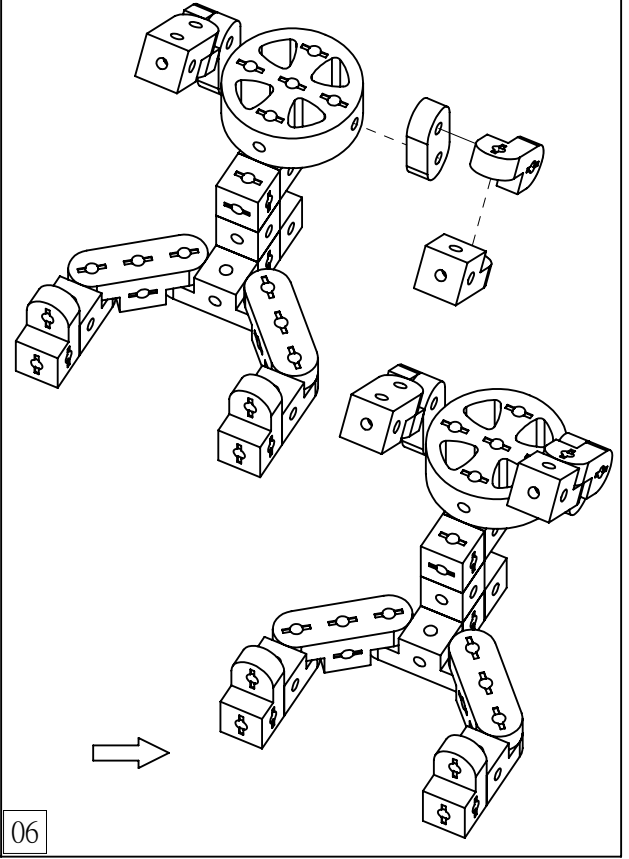

06



II

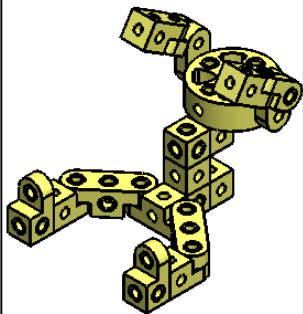

01

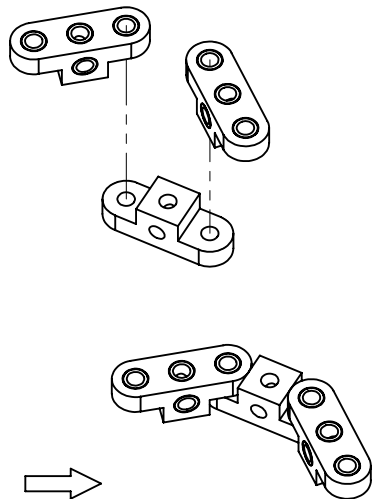

02

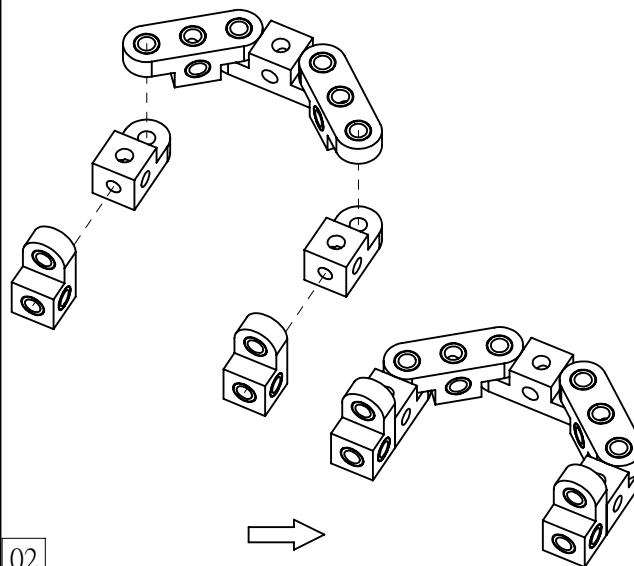

03

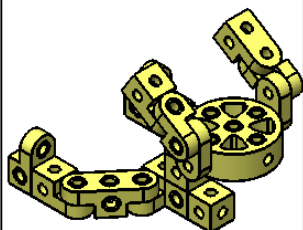
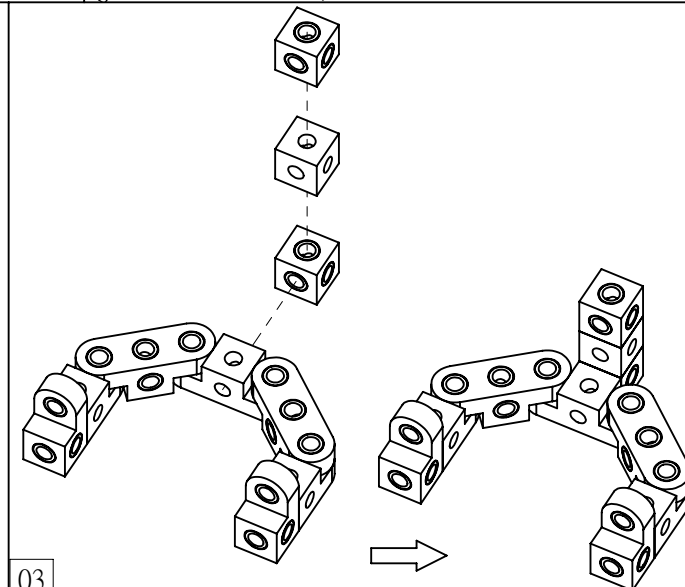

04

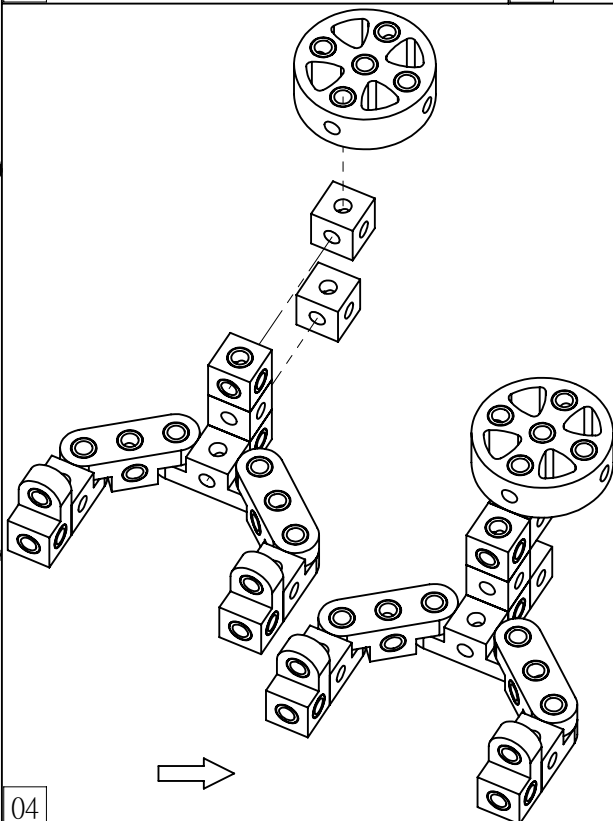

05

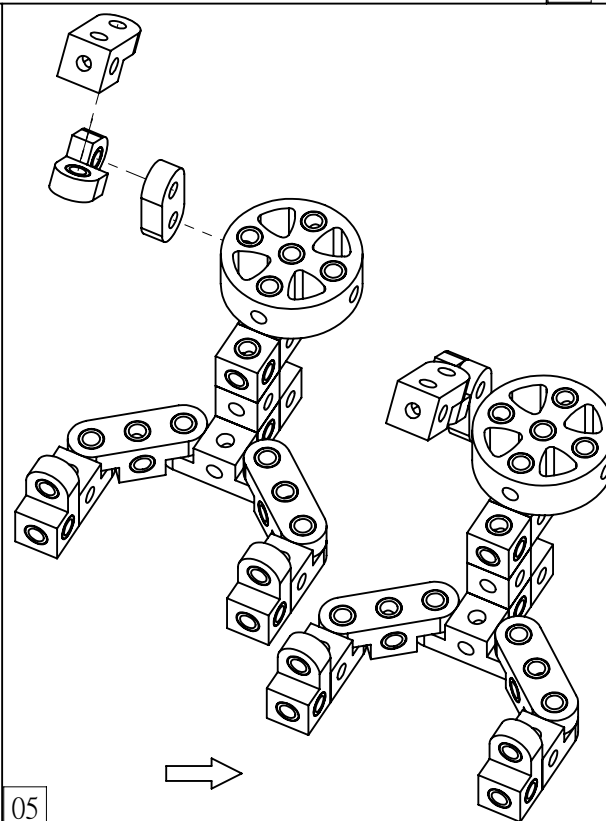

06

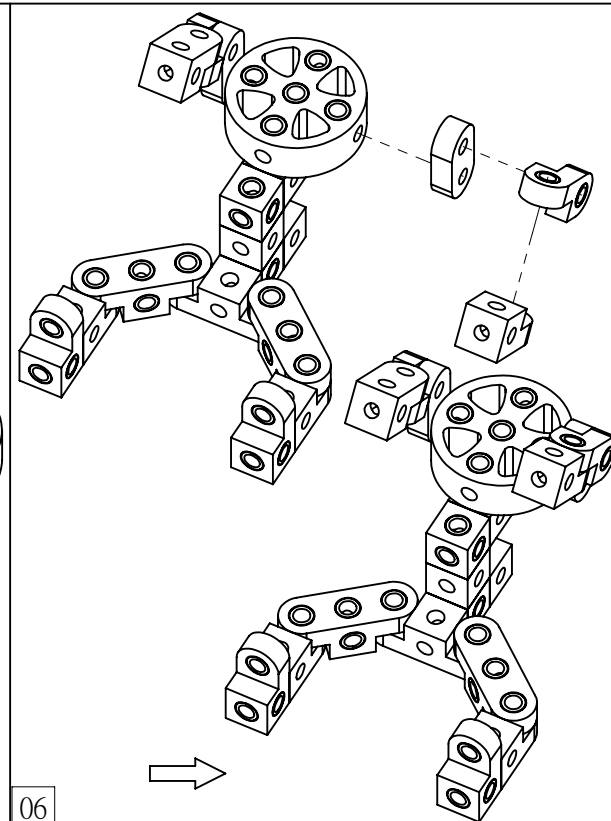

III

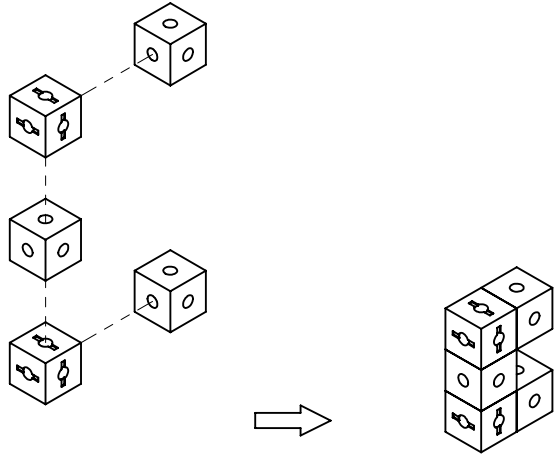
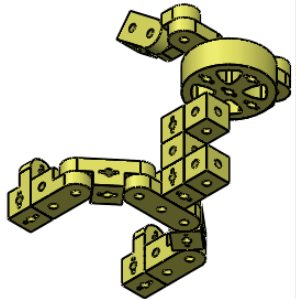
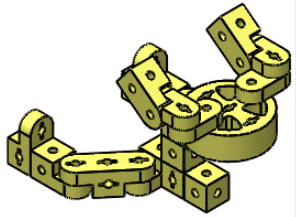
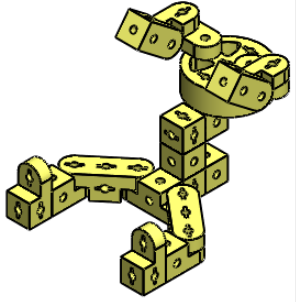

01

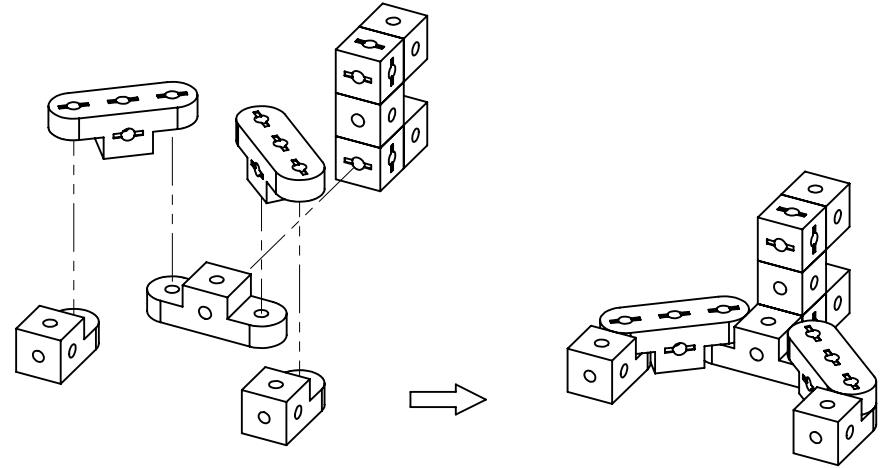

02

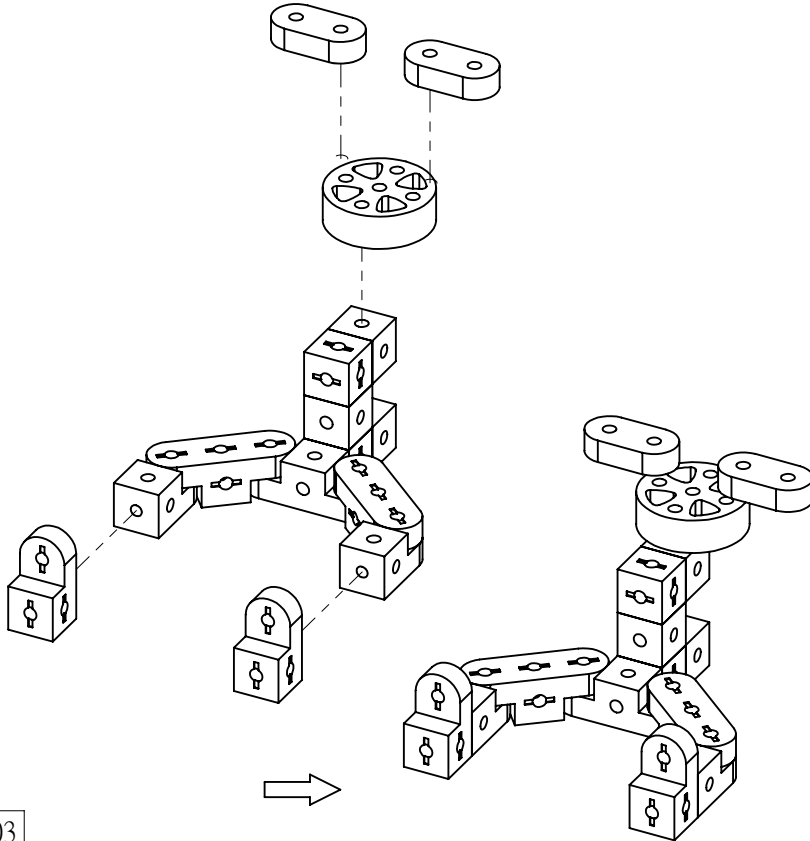

03

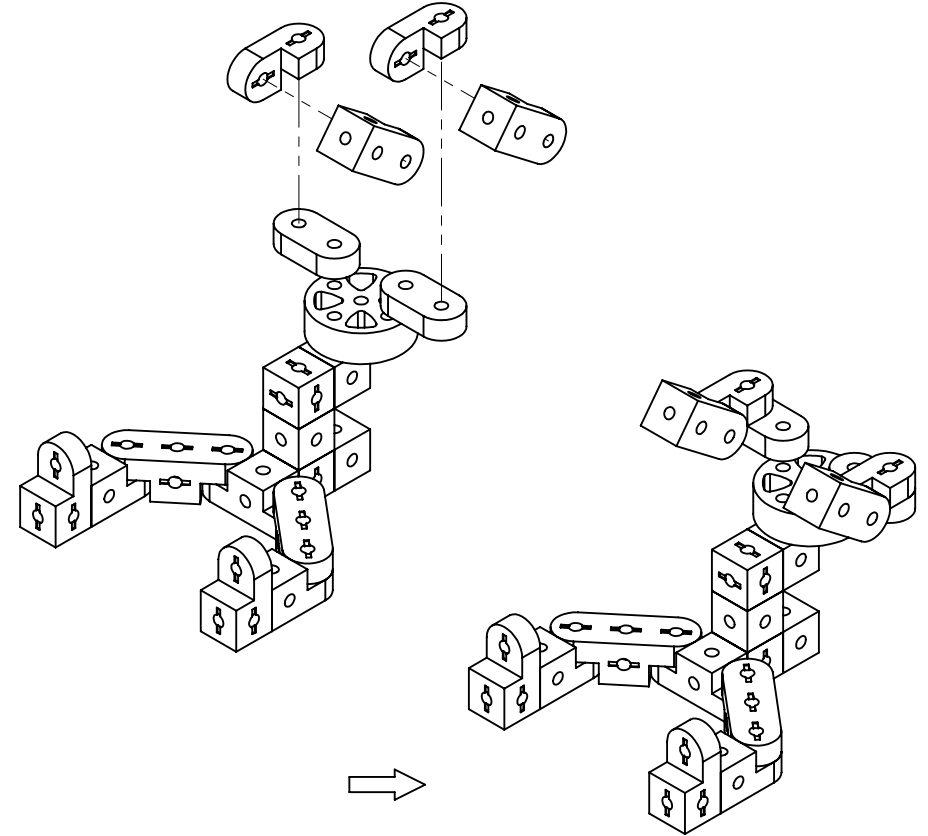

04



IV

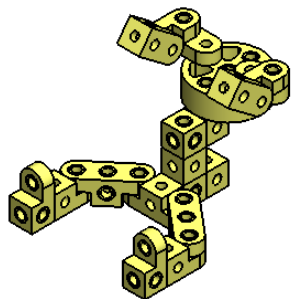

01

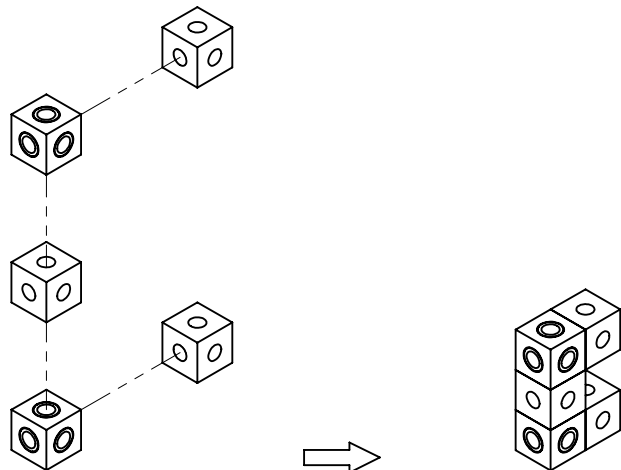

02

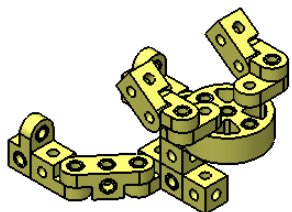
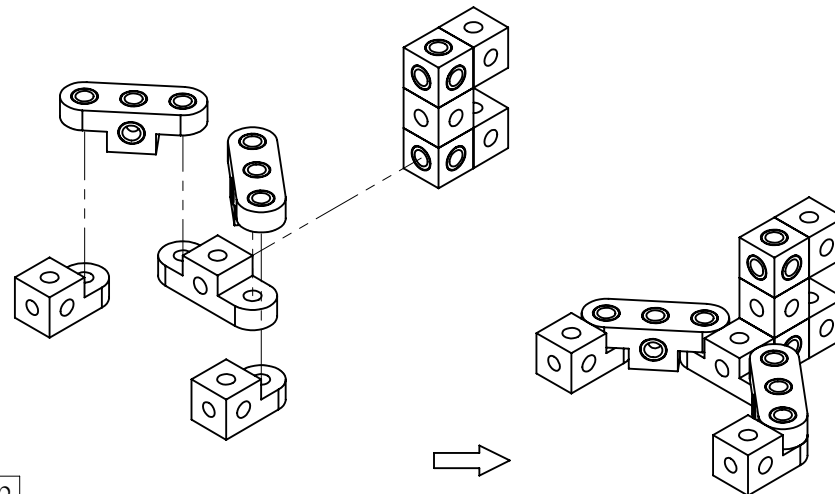

03

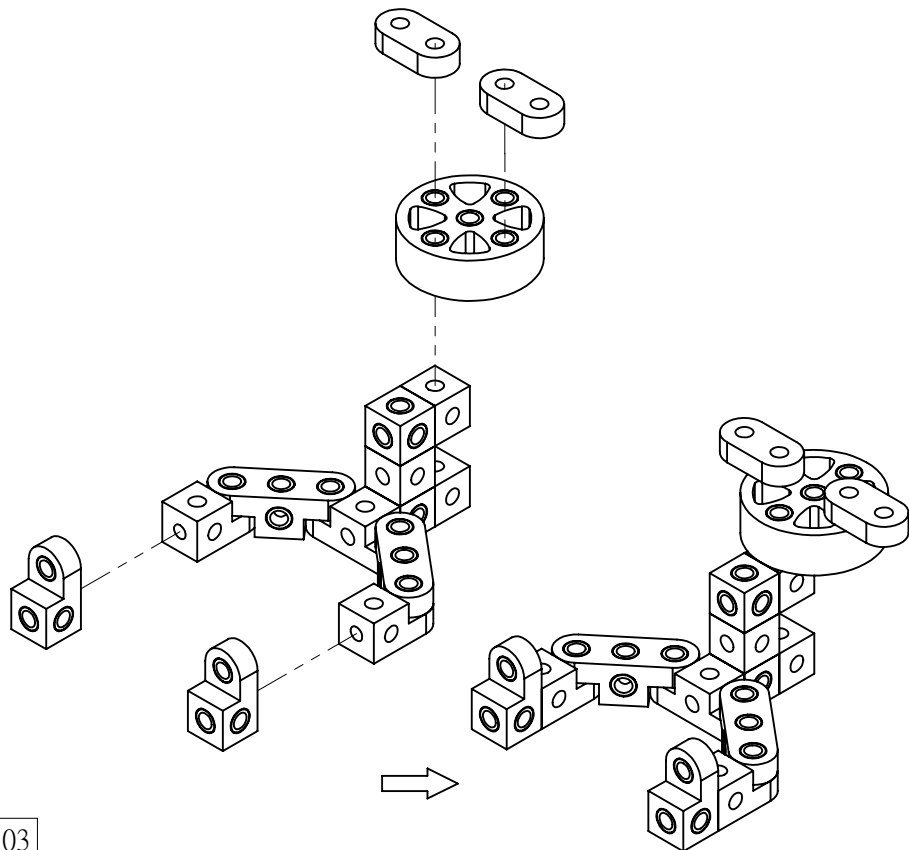

04

