

I

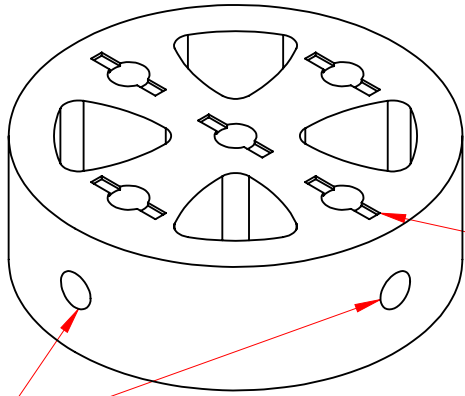

負牙標記
"- " block
if any of
the threaded
hole has a
"- " mark

有側孔
With side hole

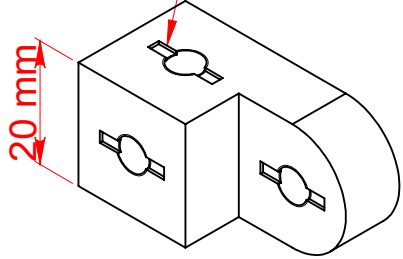

II

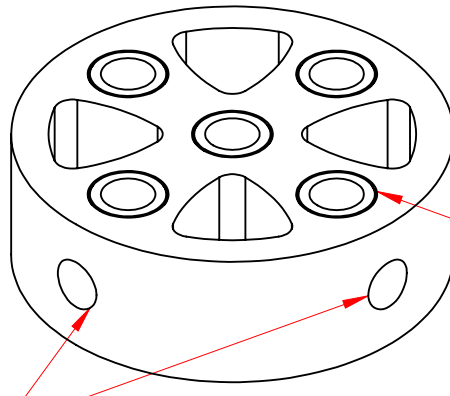

負牙標記
"- " block
A circular
ring outside
each threaded
hole

有側孔
With side hole

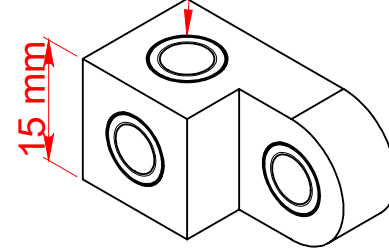

V

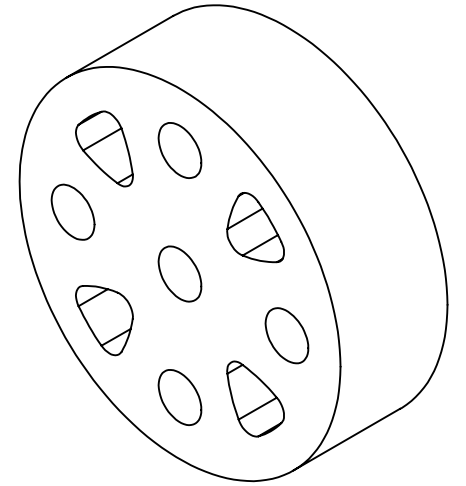

III

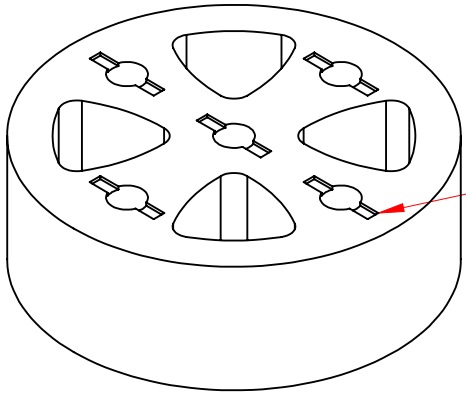

負牙標記
"- " block
if any of
the threaded
hole has a
"- " mark

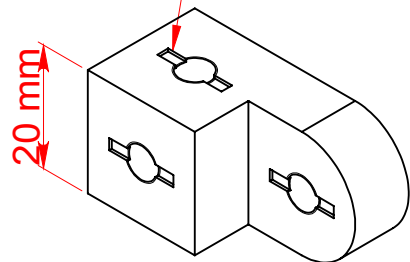

IV

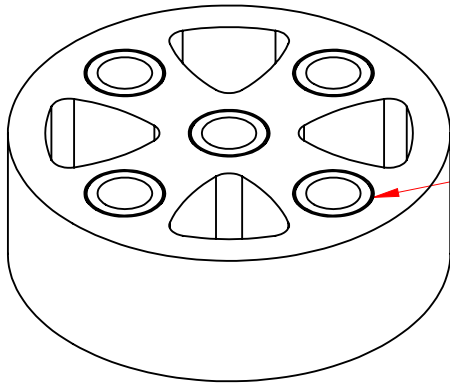

負牙標記
"- " block
A circular
ring outside
each threaded
hole

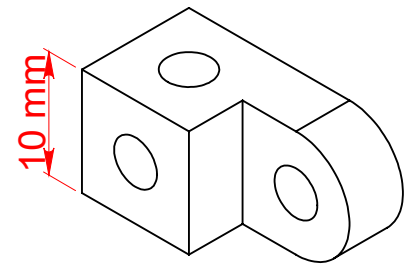
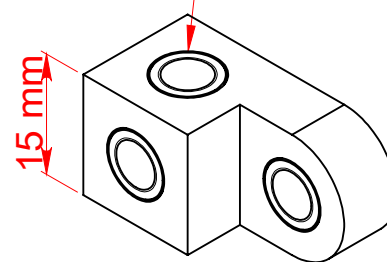

III

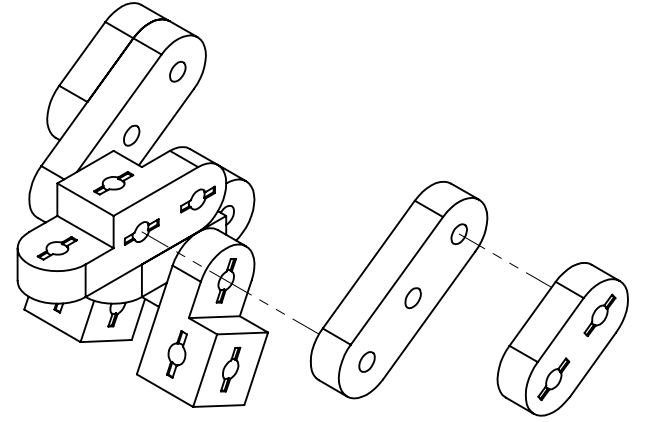
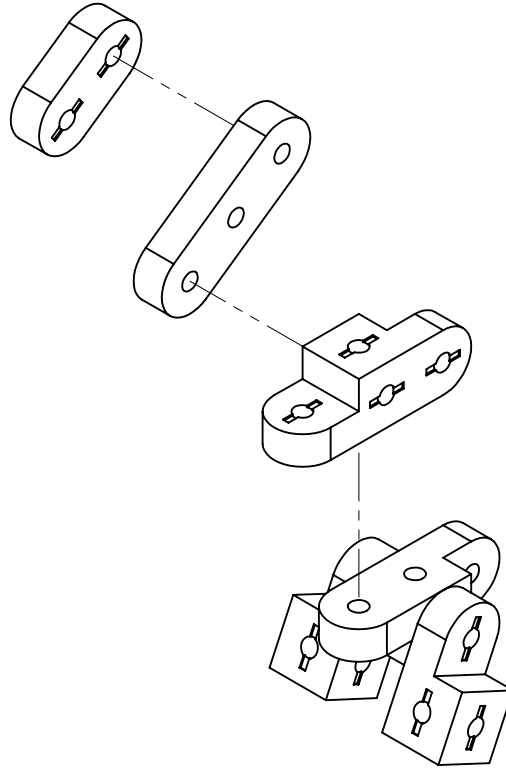
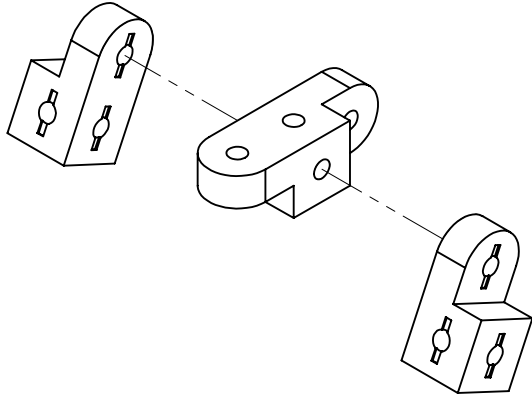
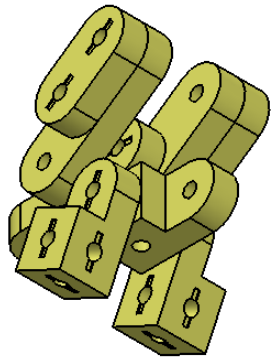
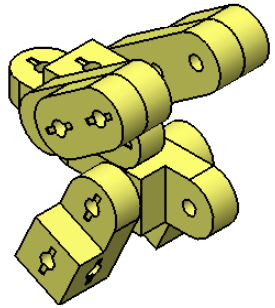
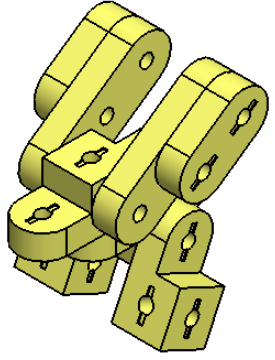

04

05

06



IV

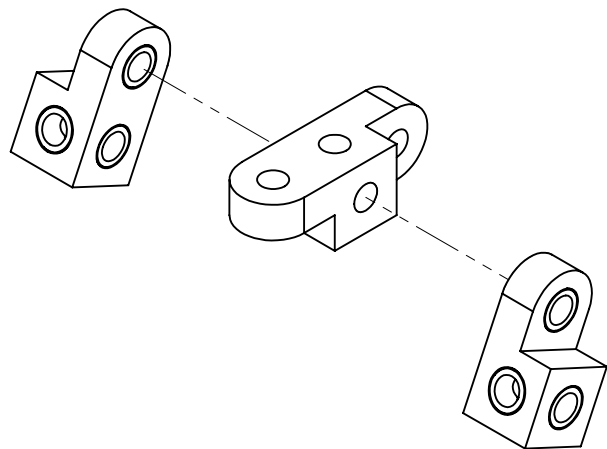
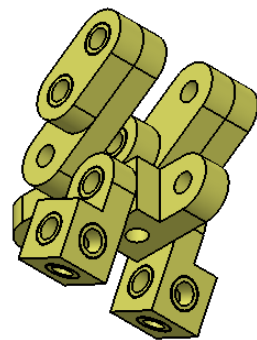
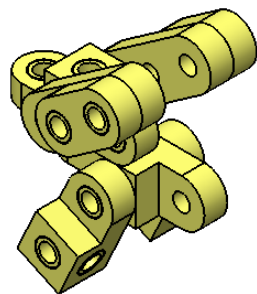
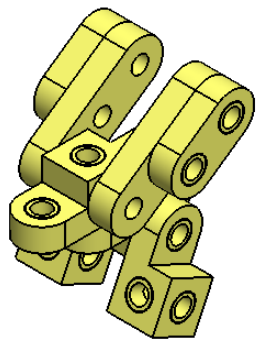

01

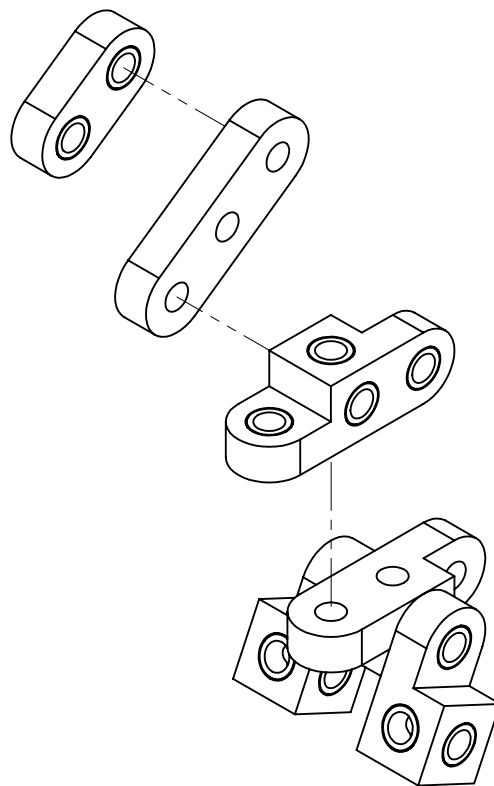

02

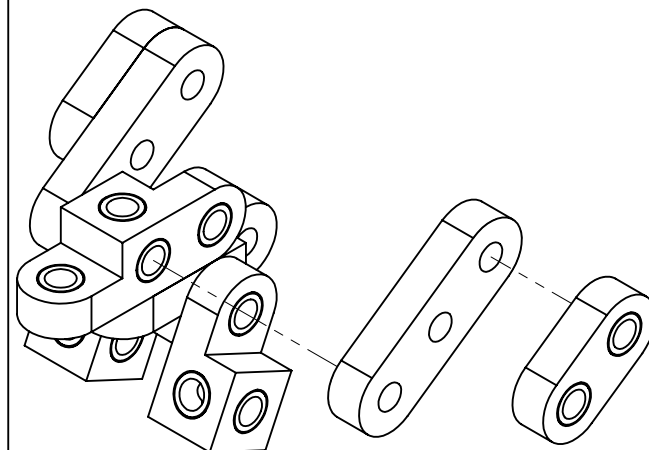

03