

I 20mm ○

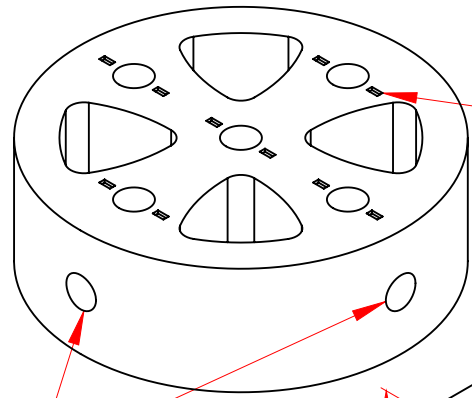

負牙標記
"- " block
if any of
the threaded
hole has a
"- " mark

有側孔
With side hole

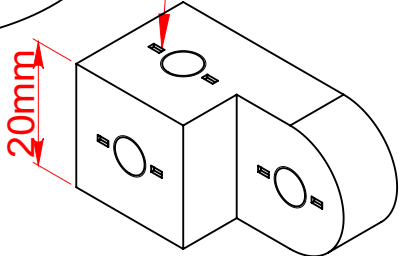

I 20mm ⊗

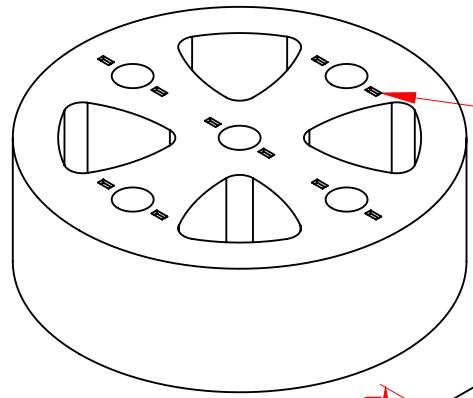

負牙標記
"- " block
if any of
the threaded
hole has a
"- " mark

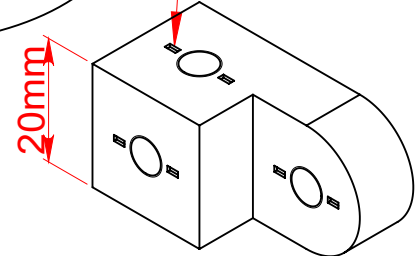

III 10mm

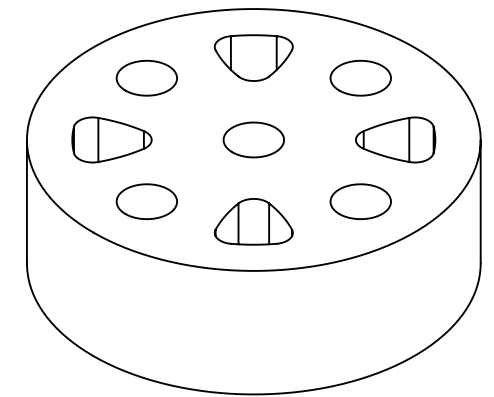

II 15mm ○

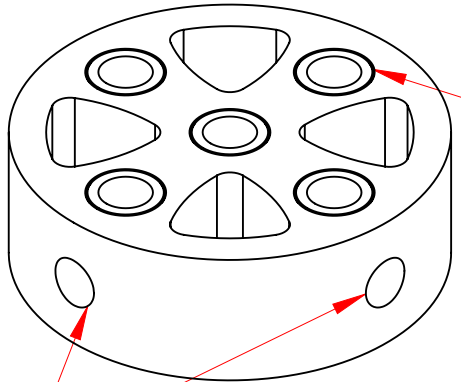

負牙標記
"- " block
A circular
ring outside
each threaded
hole

有側孔
With side hole

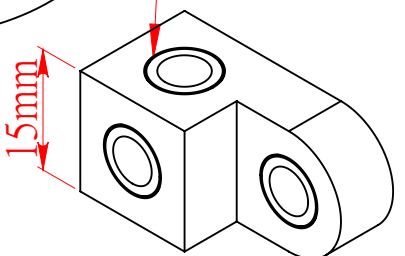



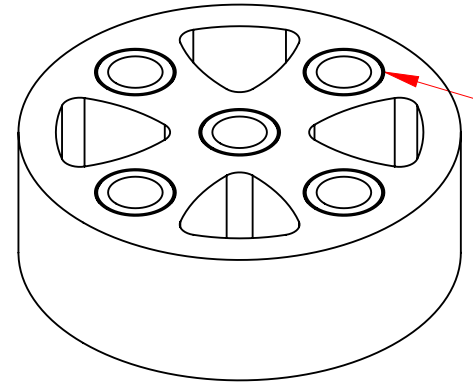

II 15mm ⊗

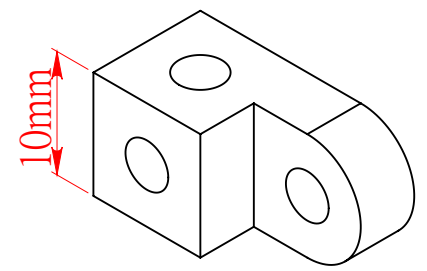
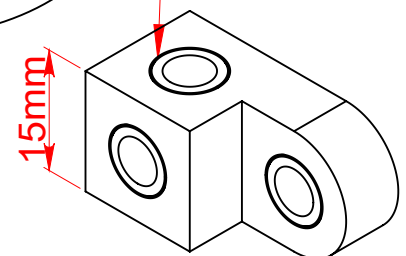

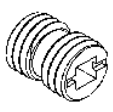
負牙標記
"- " block
A circular
ring outside
each threaded
hole



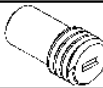
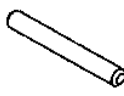
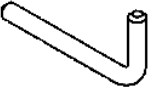
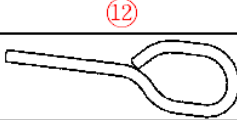



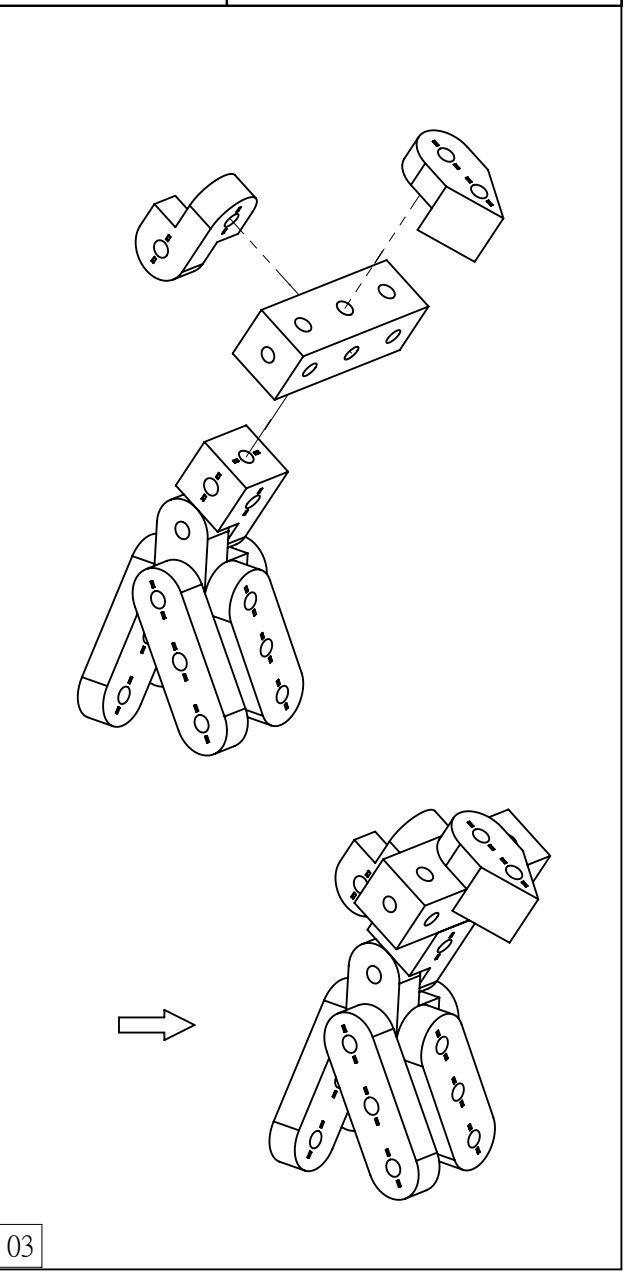
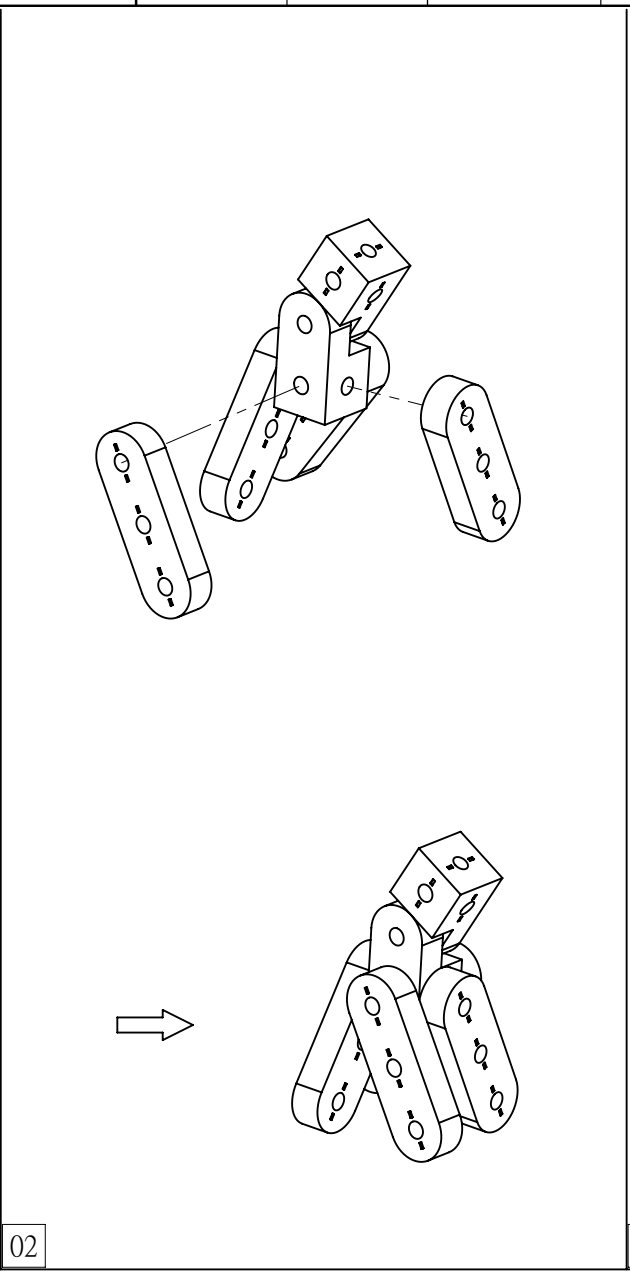
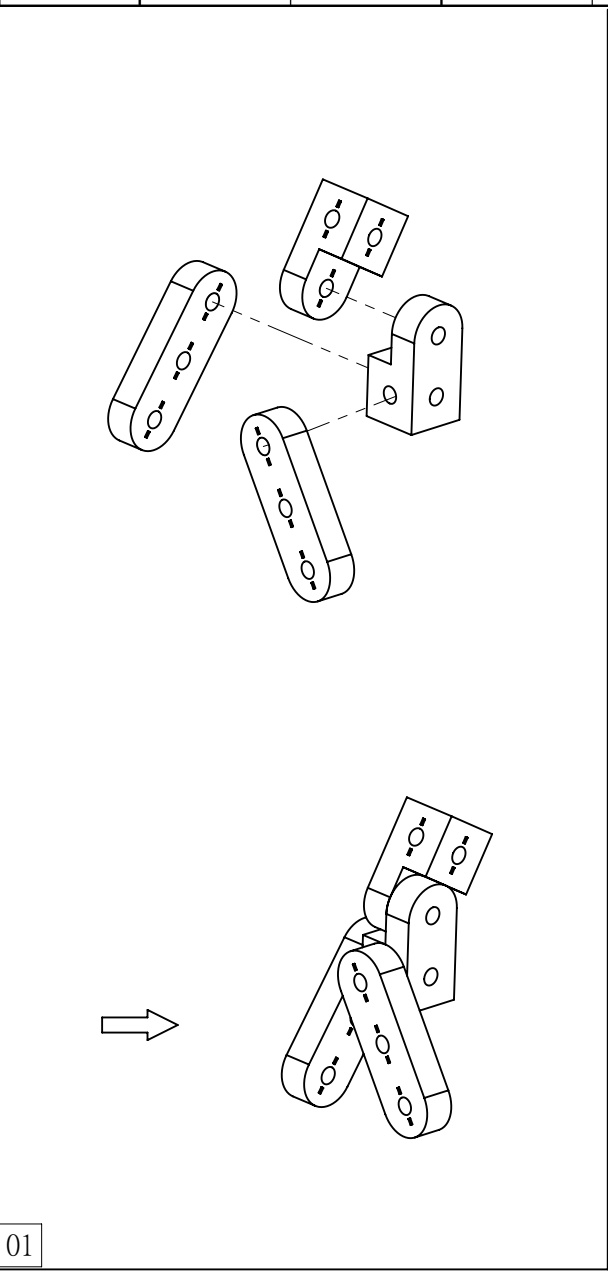
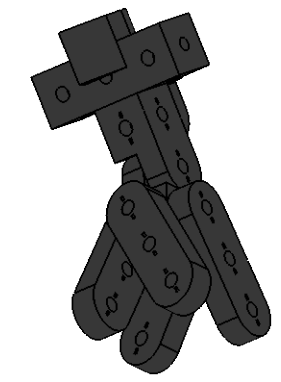
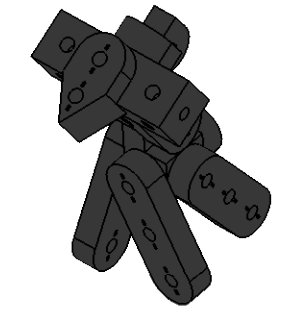
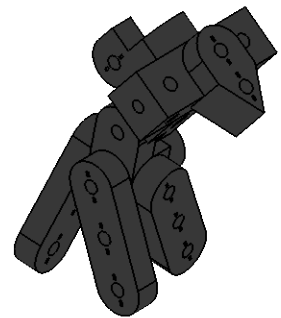

		① + 	② - 	③ + 	④ - 			⑫ 
1	9	2	1			2		

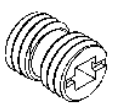
⑤ 5 cm * 1
⑥ 7 cm * 1

I 20mm ⊗

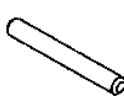

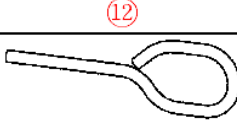
		① + 	② - 	③ + 	④ - 			⑫ 	⑤ 4 cm * 1 ⑥ 5 cm * 1
1	9	2	1			2			

II 15mm ⊗

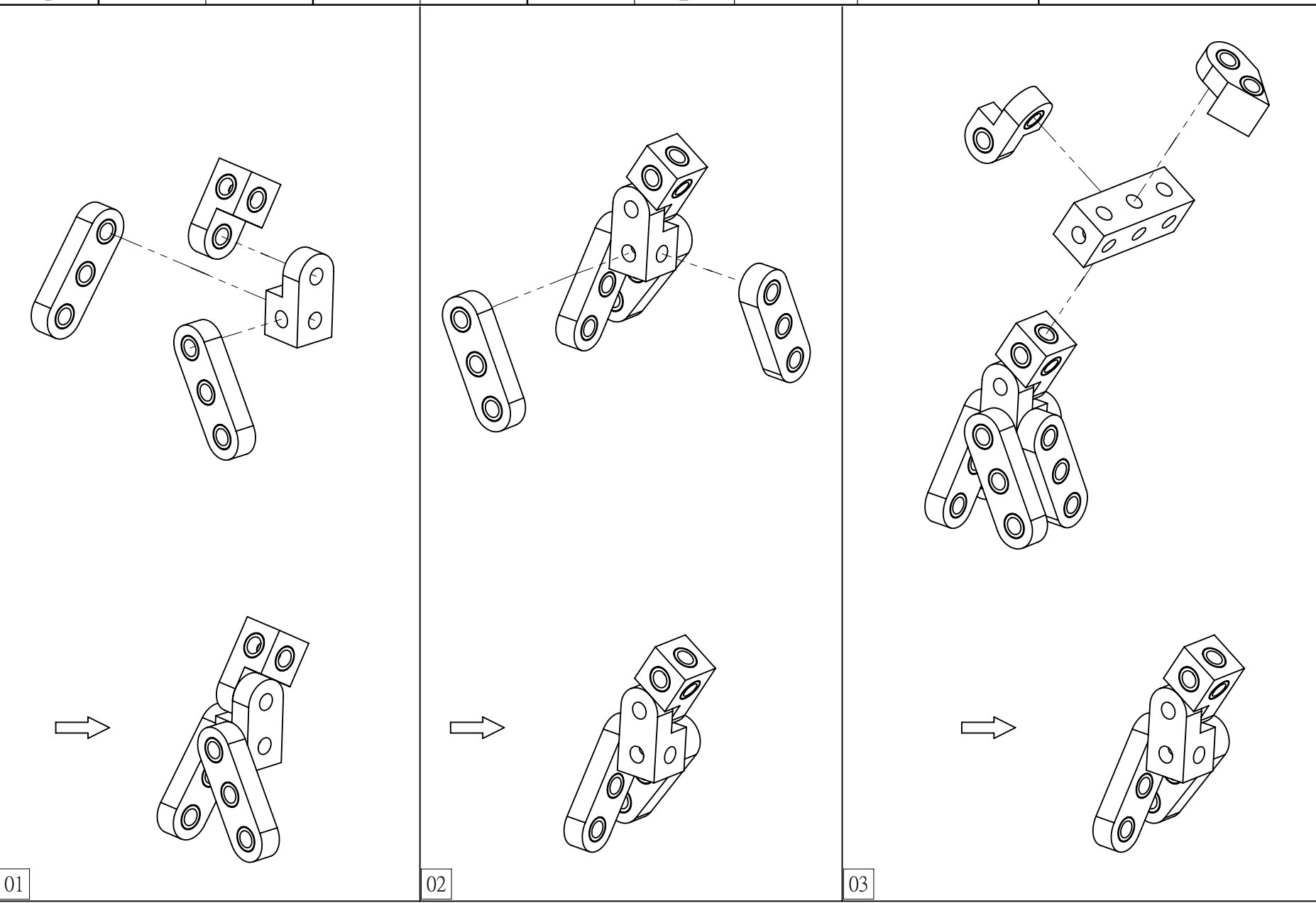
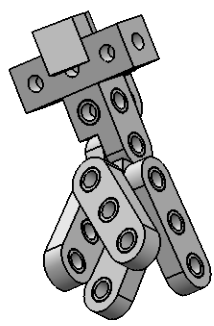
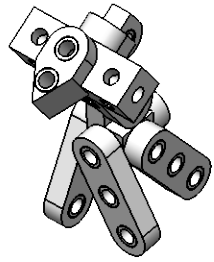
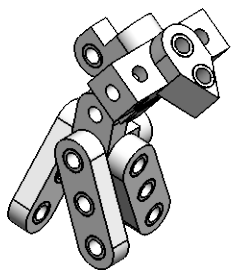

01

02

03