

05-1題型

解答順序

01 ~ 12
或
12 ~ 01

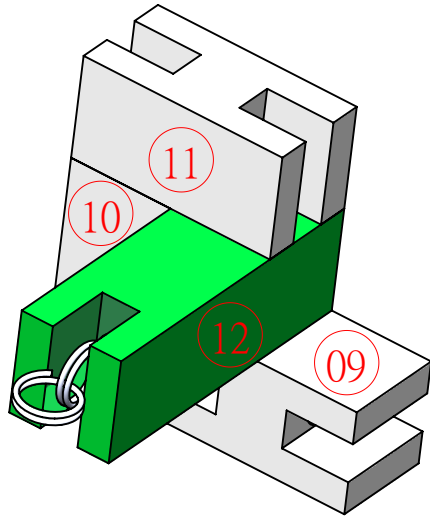
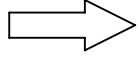

01

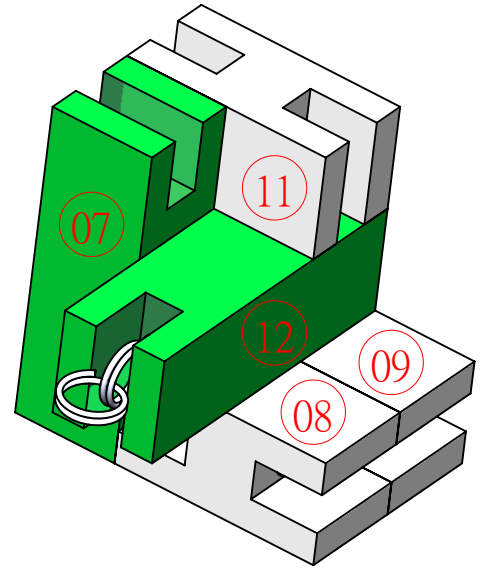
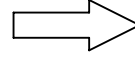

02

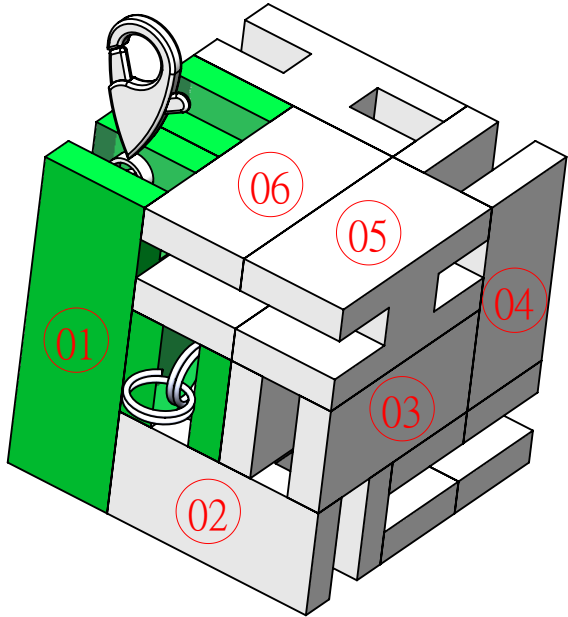

04

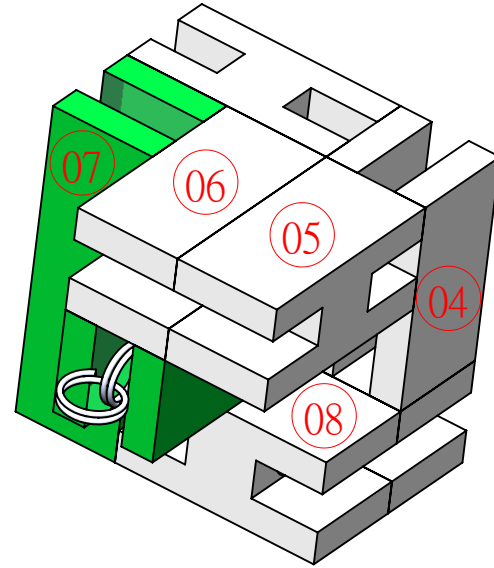
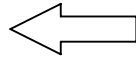

03

