

03-1題型

解答順序

① ~ ⑫
或
⑫ ~ ①

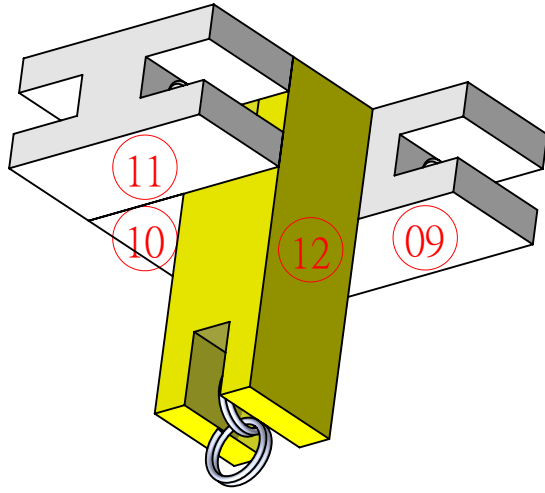
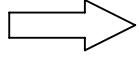

01

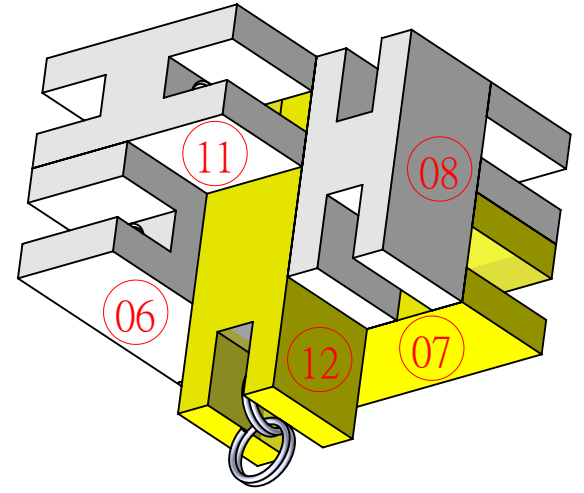
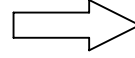

02

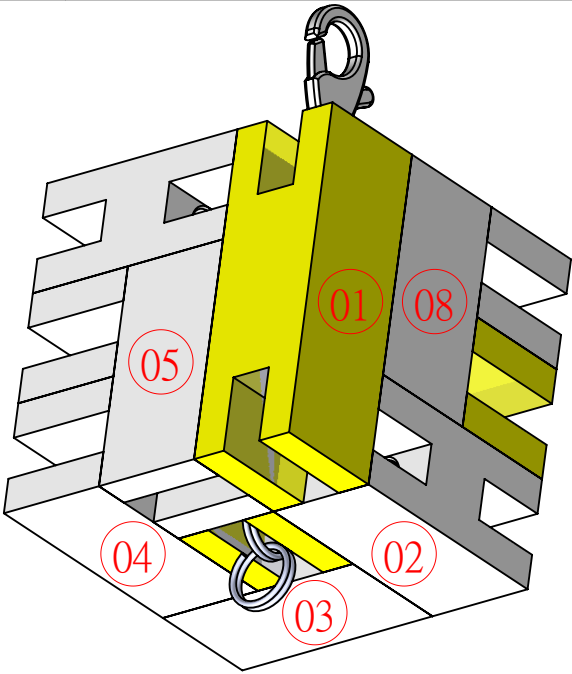

04

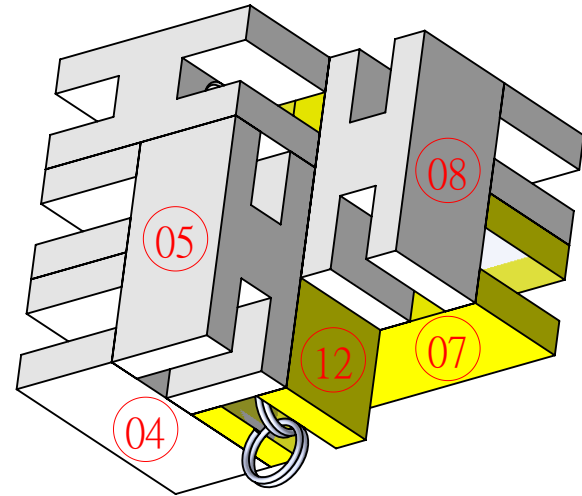
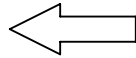

03

