

02-1題型

解答順序

① ~ ⑫  
或  
⑫ ~ ①

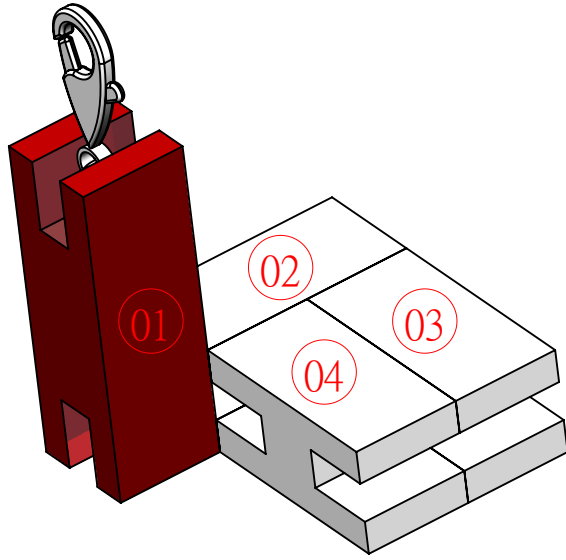
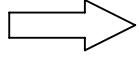

01

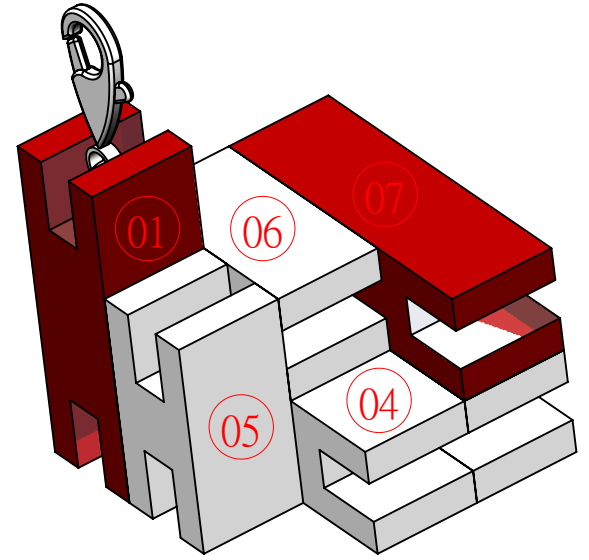
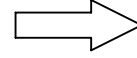

02

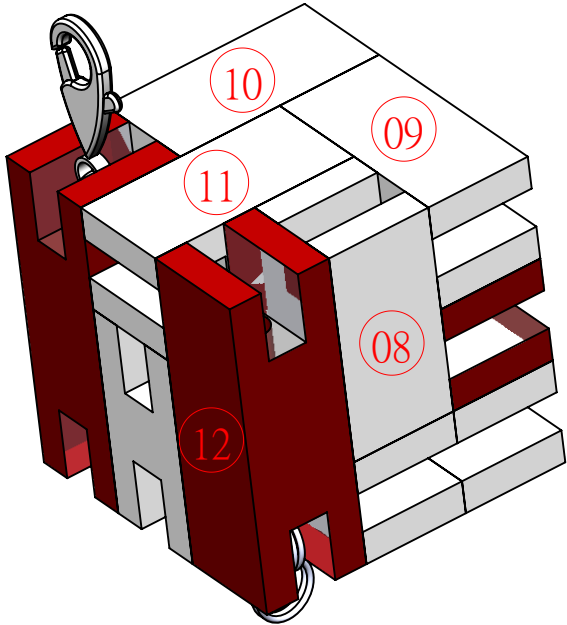

04

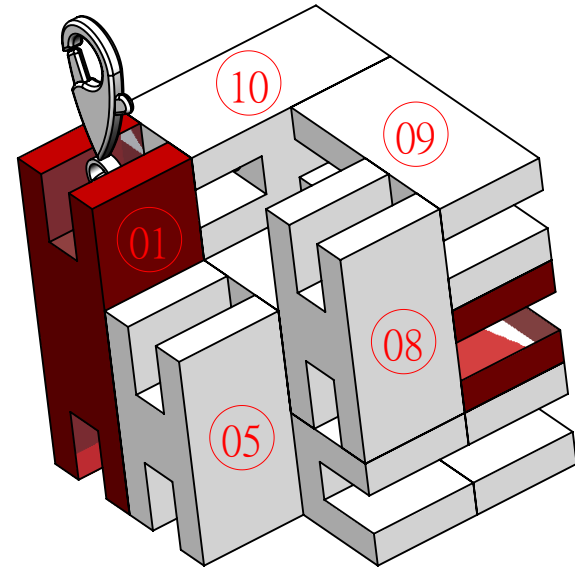
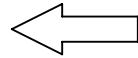

03

