

01-1題型

解答順序

01 ~ 12
或
12 ~ 01

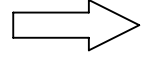

01

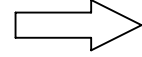
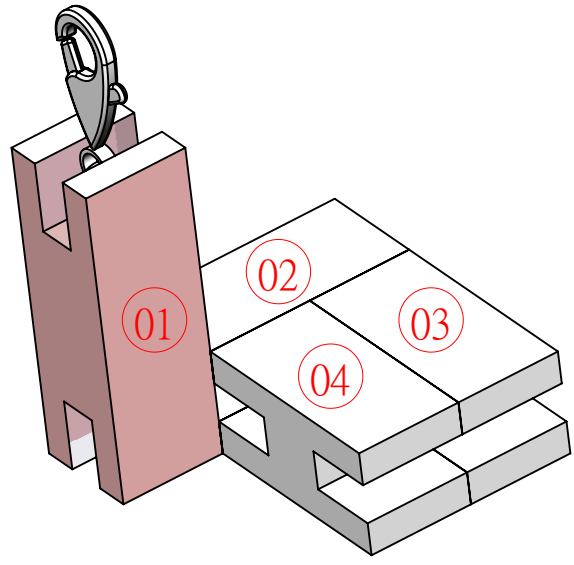

02

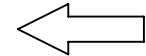
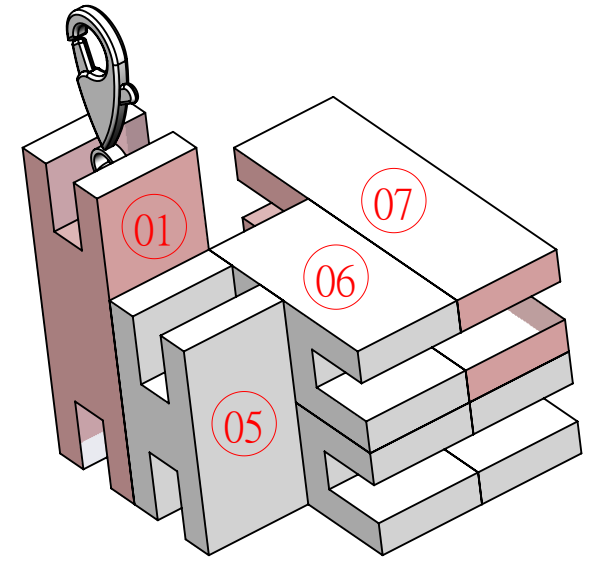

04

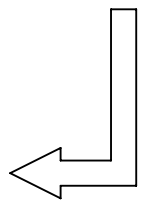
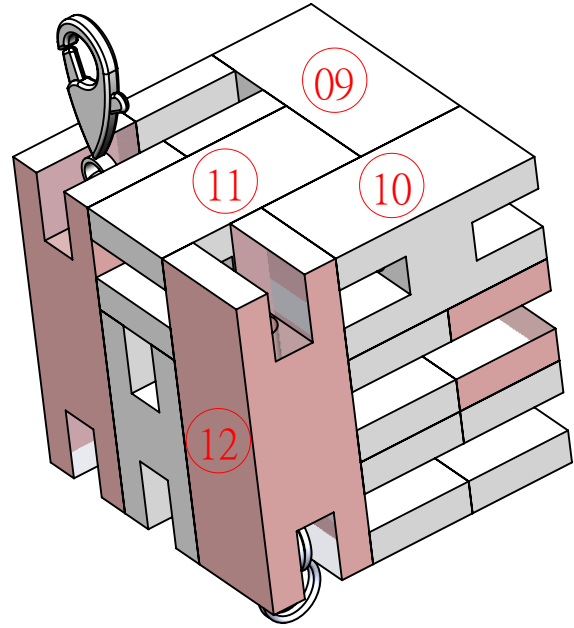

03

